

Model: GW12-800WL(12V 250Ah)

GW Series

VLRA High Rate Discharge Battery



Legacy Canadian products designed in Canada, assembled in China.

Connecting To Legacy

📍 Laval-Quebec-Canada

📍 Beirut-Lebanon

📍 Hongkong-China

🔍 www.connectinglegacy.com

Introduction	GW12-800WL(12V 250Ah)
Length	522±2mm (20.6 inches)
Width	240±2mm (9.45 inches)
Height	219±2mm (8.62 inches)
Total Height	224±2mm (8.82 inches)
Weight	Approx. 72.0Kg (Tolerance±5%)
Terminal	Default F10(M8), Value: 10~12N*m
Container Material	A.B.S. UL94-HB, <UL94-V0 Optional>
Design Life	15 years
Application	UPS/EPS,Electric Tools,Toys,Medical,Wheelchair and Security System etc.

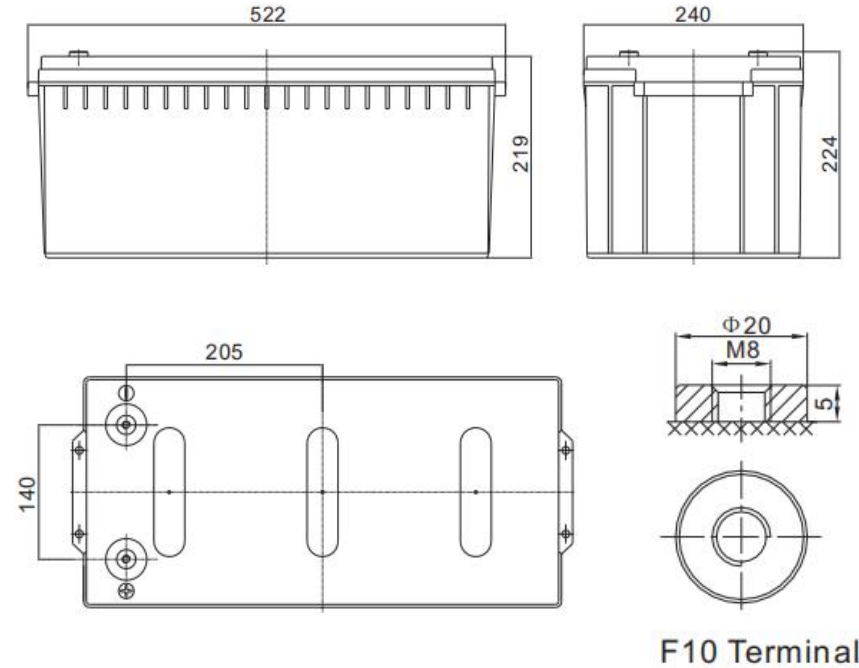

F10 Terminal

GW12-800WL Dimension

Structure: Compact design of shorter internal connectors among cells for lower I.R.

Plate: Pasted flat type with patent high rate formula of AM supports stable performance during high current discharge.

Features

Separator: Improved AGM separator increases deep cycle life.

Safety Valve:Flame arrester/filter is equipped with safety valve system.

Design and manufacture with DIN standards by Legacy team, for heavy load discharge applications.

Parameters	GW12-800WL (12V 250Ah)
Cell Per Unit	6
Voltage Per Unit	12V
Nominal Capacity	800W@15min-rate to 1.67V per cell @25°C
Internal Resistance	≤2.4 mΩ(Full Charge Condition @25°C)
Max. Discharge Current	2500A (5 sec)
Max. Charging Current	75.0A
Short Circuit Current	4300A
Reference Capacity	C10: 245.0Ah C20: 250.0Ah
Standby Use Voltage	13.50 V~13.62 V @ 25°C Temperature Compensation: -3mV/°C/Cell
Cycle Use Voltage	14.10 V~14.40 V @ 25°C Temperature Compensation: -4mV/°C/Cell
Normal Operating Temperature Range	25°C±5°C
Operating Temperature Range	Discharge and Storage : -20°C~60°C Charge: 0°C~50°C
Self Discharge	Monthly Self-discharge ratio is less than 3% at 25°C
Note	Legacy GW batteries can be stored for up to 6 months at 25°C and recharging is recommended. Please charged batteries before using.



GW12-800WL Imagine

F.V/TIME	5 MIN	8 MIN	10 MIN	15 MIN	20 MIN	30 MIN	60 MIN	90 MIN
1.60V	695.4	608.8	550.8	442.4	360.2	265.5	153.6	110.3
1.65V	631.1	558.3	509.1	412.5	251.2	251.2	146.6	105.8
1.70V	604.2	536.6	490.8	400.0	245.2	245.2	143.7	103.7
1.75V	557.9	499.8	460.1	378.4	234.8	234.8	138.7	100.5
1.80V	511.1	462.9	429.4	358.0	224.9	224.9	133.7	97.20
1.85V	438.7	394.3	363.8	307.9	198.9	198.9	120.8	88.62



Constant Current Discharge
Ah/Cell (@ 77°F/25°C)

Model: GW12-800WL

F.V/TIME	5 MIN	8 MIN	10 MIN	15 MIN	20 MIN	30 MIN	60 MIN	90 MIN
1.60V	1278	1171	1058	843.2	692.3	515.9	288.6	208.7
1.65V	1189	1098	998.3	800.0	660.7	494.7	277.7	201.7
1.70V	1150	1065	970.4	781.4	646.5	484.7	273.2	198.9
1.75V	1079	1007	921.7	747.6	620.5	468.7	265.7	193.6
1.80V	1005	945.0	870.4	714.3	597.2	452.3	257.7	188.3
1.85V	875.1	816.3	747.3	620.9	523.2	403.4	234.4	173.2



Constant Power Discharge
W/Cell (@ 77°F/25°C)

Discharge Characteristics Curve

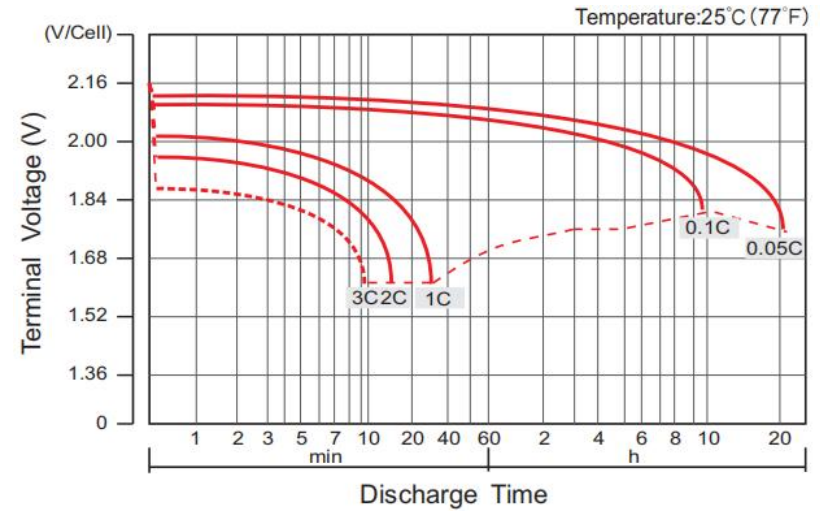

Charge Characteristics Curve For Standby Use(IU)

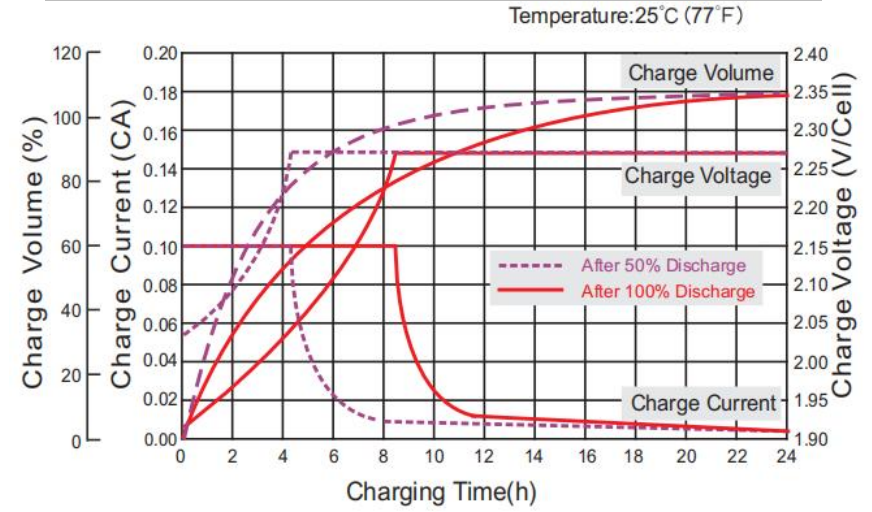

Cycle Life in Relation to Depth of Discharge

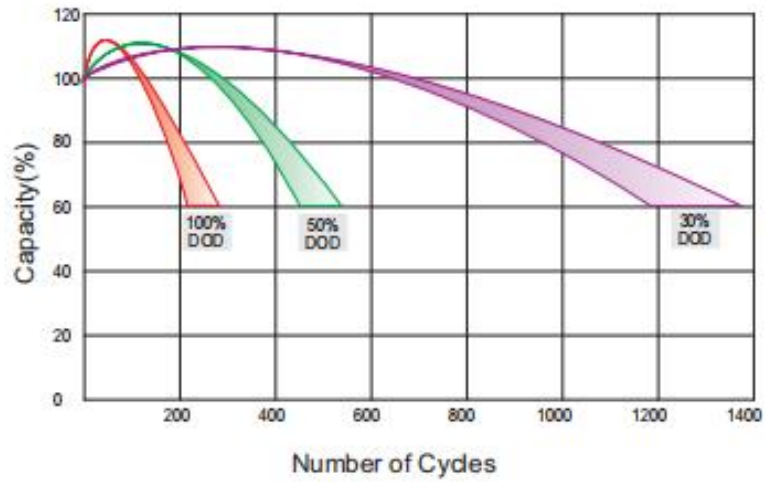

Relationship Between Charging Voltage and Temperature

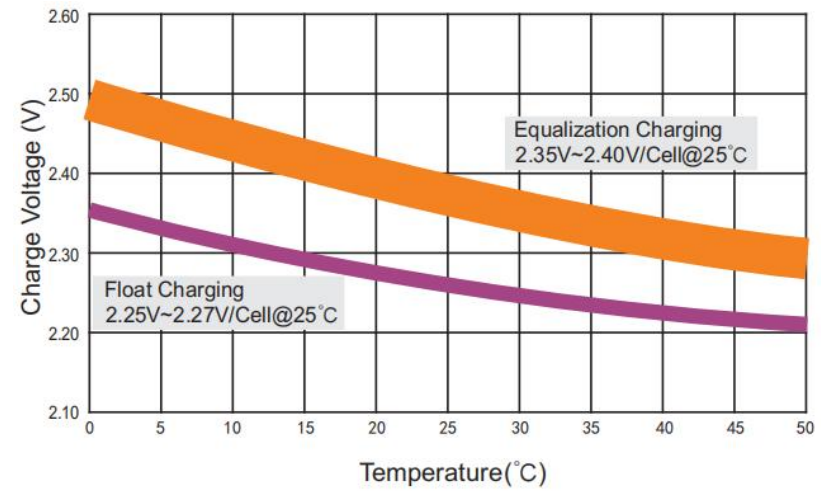

Note: The above data are average values, and can be obtained within 3 charge/discharge cycles. These are not minimum values. Cell and battery designs/specifications are subject to modification without notice. Legacy reserves the right to explain and update the latest information.

Life Characteristics of Standby Use

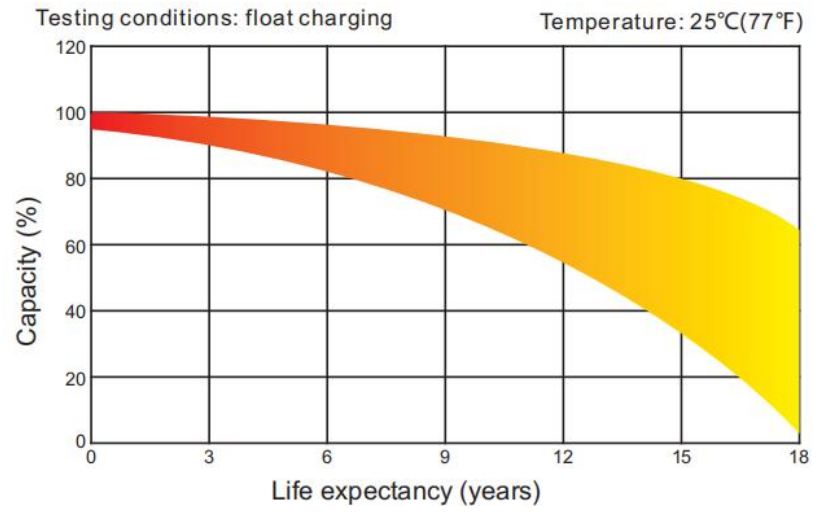

Storage Characteristics

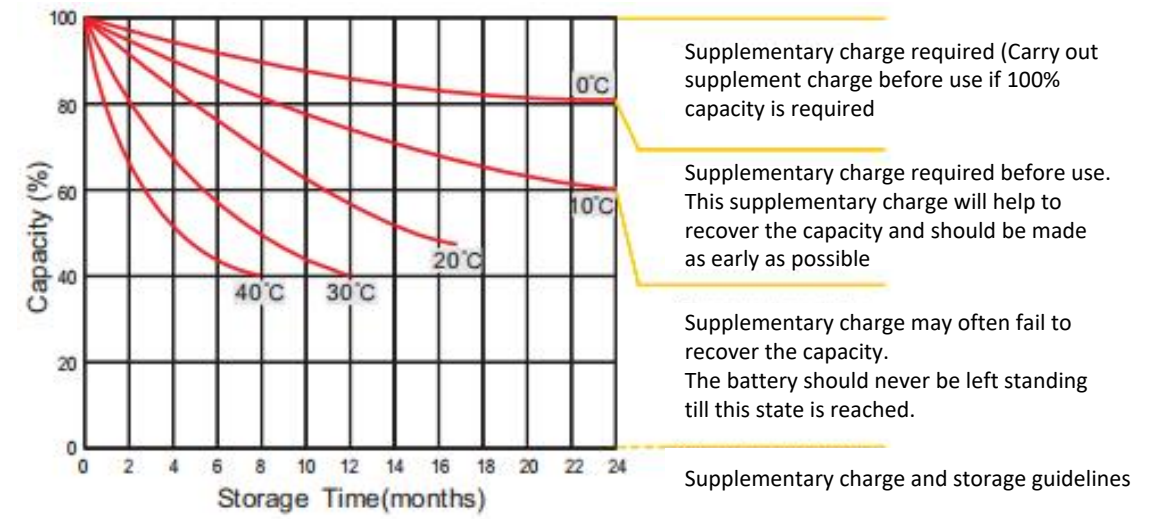

Effect of Temperature on Longterm life

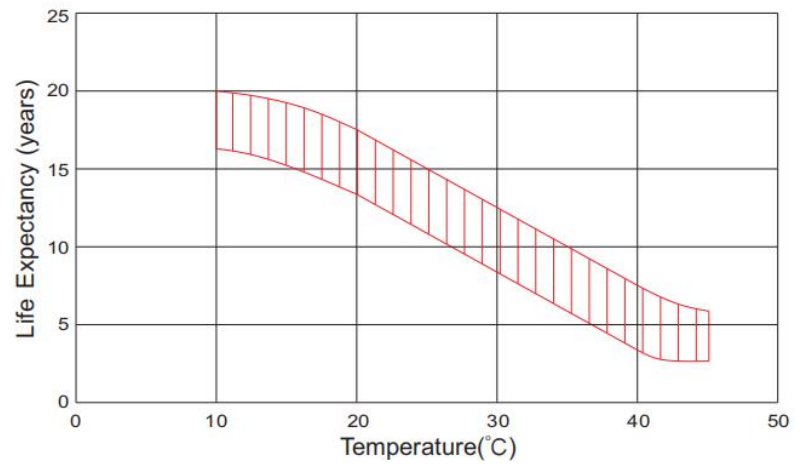

Relationship of OCV and State of Charge(20°C)

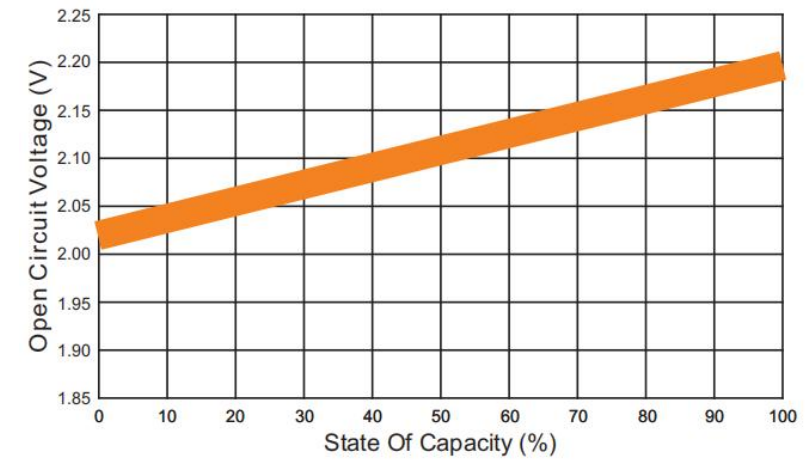

Note: The above data are average values, and can be obtained within 3 charge/ discharge cycles. These are not minimum values. Cell and battery designs/specifications are subject to modification without notice. Legacy reserves the right to explain and update the latest information.



LET'S DEVELOP TRUST AND BUSINESS

Connecting To Legacy